



GENUINE PARTS

INSTALLATION INSTRUCTIONS

DESCRIPTION:	Shift Knob Replacement
APPLICATION:	Maxima
PART NUMBER:	T99N6 4RAXA (x - different colors)

KIT CONTENTS:

Item	Qty.	Part Description	Service Part Number
A	1	Shift Knob Replacement	T99N6 4RAXA
B	1	Installation Instruction Replacement Template	999V2 AW000



A



B

TOOLS REQUIRED:

- Needle Nose Pliers

PRE-INSTALLATION WARNINGS, CAUTIONS, CRITICAL STEPS, and NOTES:

- Dealer Installation Recommended. Instructions may refer to Service Manual.

⚠ CAUTION

- **Install straight. Never tap or apply any shock to install.**
- **Do not press selector button until installation is complete.**

INSTALLATION PROCEDURE:

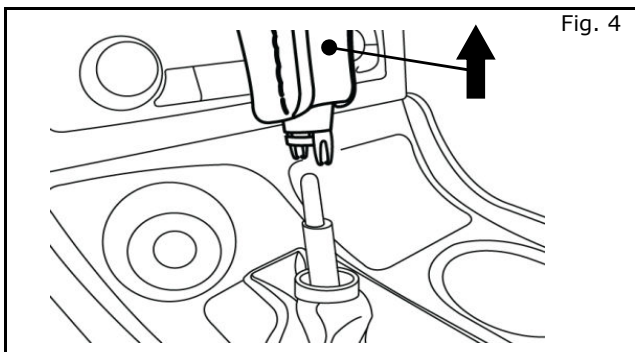
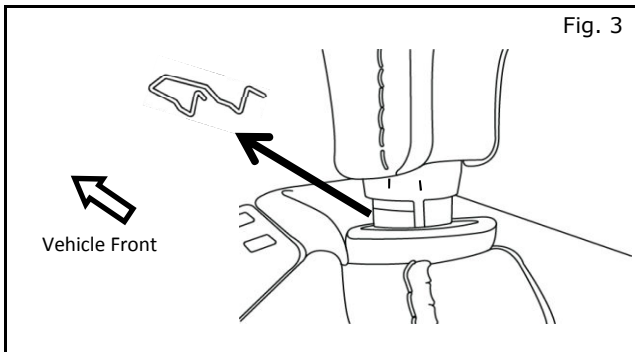
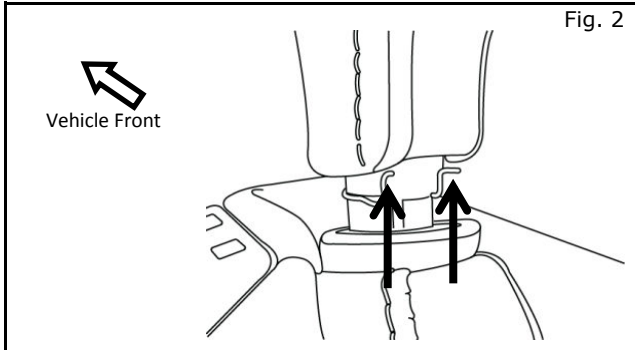
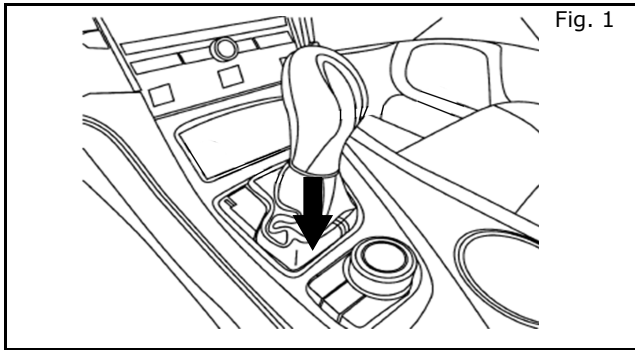

- 1) Apply the parking brake.
- 2) Make sure shifter is in "P" position.
- 3) Grip the top of shift boot at the selector lever knob and slide the shift boot down. **(Fig. 1)**
- 4) Locate the 2 ends of the spring clip. **(Fig. 2)**
- 5) Use needle nose pliers to grip one end of the spring clip and use your fingers to push out the other end of the spring clip.
- 6) Gently spread the spring clip open and slide forward to remove. **(Fig. 3)**
- 7) Pull up the shift knob from the selector lever and discard clip and knob. **(Fig. 4)**

INSTALLATION PROCEDURE:

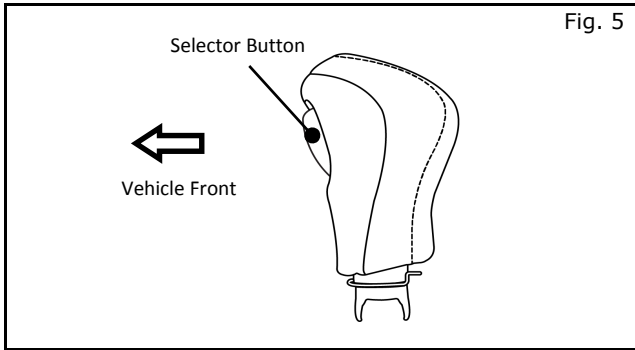

- 8) Orient the new knob so the selector button is facing forward. **(Fig. 5)**

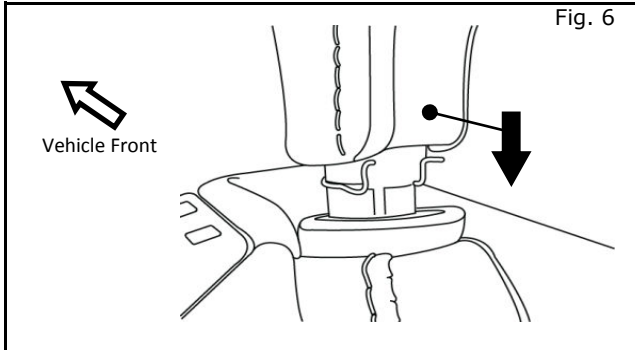

- 9) Insert the new shift knob into the selector lever until it clicks. **(Fig. 6)**

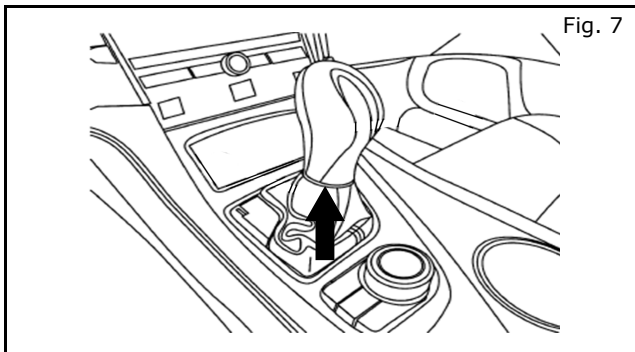

- 10) Slide shift boot back up onto the shift knob. **(Fig. 7)**

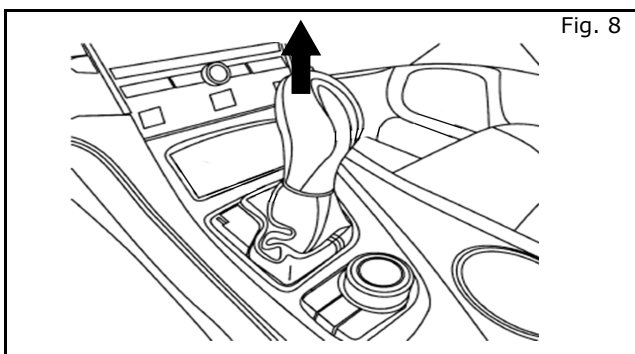

- 11) Pull the knob up by hand to confirm it is properly secured in position. **(Fig. 8)**